

MAXIMUS

MEGA SLAB

Countertop
Solutions

MAXIMUS
MEGA SLAB

RAK
CERAMICS

Countertop Solutions

CONTENTS

MARBLE

| | |
|--------------------|----|
| BRECCIA ADIGE | 42 |
| BRECCIA DAINO | 42 |
| BLU DEL BELGIO | 43 |
| CALACATTA AFRICA | 46 |
| CALACATTA GOLD | 46 |
| CALACATTA EXTRA | 47 |
| CLASSIC CARRARA | 48 |
| CLASSIC ONYX | 54 |
| CLASSIC FIORITO | 49 |
| CLASSIC FLURRY | 54 |
| CLASSIC NEW MARFIL | 49 |
| ELLE MARBLE | 47 |
| MEDICEA MARBLE | 55 |
| PANDA MARBLE | 55 |
| PALISSANDRO | 56 |
| RAIN MARBLE | 57 |
| SILK MARBLE | 60 |
| URBAN MARBLE | 56 |
| VERSILIA MARBLE | 57 |

WOOD

| | |
|--------------|-----|
| BENGALA | 110 |
| BAILLIE WOOD | 110 |
| DENVER WOOD | 110 |

CONCRETE

| | |
|--------------------|----|
| ARAGON CONCRETE | 72 |
| BASIC CONCRETE XL | 72 |
| BEHIND | 74 |
| OSLO CONCRETE | 73 |
| REVIVE CONCRETE XL | 75 |
| SURFACE XL | 76 |
| TOKYO CONCRETE | 73 |

METAL

| | |
|--------------|----|
| EVOQUE METAL | 84 |
| ICON METAL | 85 |

STONE

| | |
|-----------------|-----|
| BASALTINA STONE | 100 |
| CEPPO DI GRE' | 101 |
| ICELAND STONE | 100 |
| MACAUBAS | 100 |
| NEW TRAVERTINO | 102 |

OTHERS

| | |
|-----|-----|
| UNI | 118 |
|-----|-----|

MAXIMUS

MEGA SLAB

v
λ
14.5 mm
0.57"



Countertop surfaces is the next generation of Maximus application: kitchen tops, vanity tops and stairs made from a single piece of porcelain, creating a stunning visual and seamless design.



135x305 cm
53.14"x120"

>λ
14.5 mm
0.57"





5 Stars performances

Resistant to heat

Easy to clean

Highly resistant to scratches

Highly resistant to breaking load

Resistant to freeze

Versatile

High quality raw materials



The design possibilities are endless.

Imagine a tiled space with virtually no grout lines.
Imagine limitless possibilities for your surfaces and unparalleled flexibility for any kind of applications.
Maximus is available in 3 thicknesses and a wide range of finishes and sizes.
Heat resistance, recyclable, light weight, durable and easy to clean.
Maximus is the best answer to the most challenging architectural and interior design needs.





COUNTERTOP SOLUTIONS

MARBLE



Wall: Blu Del Belgio Clay
Floor: Blu Del Belgio Clay
Kitchen Top: Blu Del Belgio Blue



Wall: Blu Del Belgio Clay
Floor: Blu Del Belgio Clay
Kitchen Top: Blu Del Belgio Blue



Counter Top and Table Top: Palissandro
Floor: Uni Ivory



Wall: Medicea Marble Hyper White
Kitchen Top: Medicea Marble Hyper White



Table Top: Medicea Marble Hyper White
Floor: Revive Concrete XL Concrete Grey



Wall and Floor: Versilia Marble Hyper White
Kitchen Top: Versilia Marble Hyper White
Furniture: Versilia Marble Hyper White and Uni Black



Furniture and Table: Panda Marble White



*Kitchen Top: Versilia Marble Hyper White
Furniture: Versilia Marble and Uni Black*



*Kitchen Top: Elle Marble White
Table Top: Uni Black*



Table: Classic Onyx



Wall and Kitchen Top: Classic Onyx



Table Top: Breccia Adige Grey



Kitchen Top: Uni Hyper White

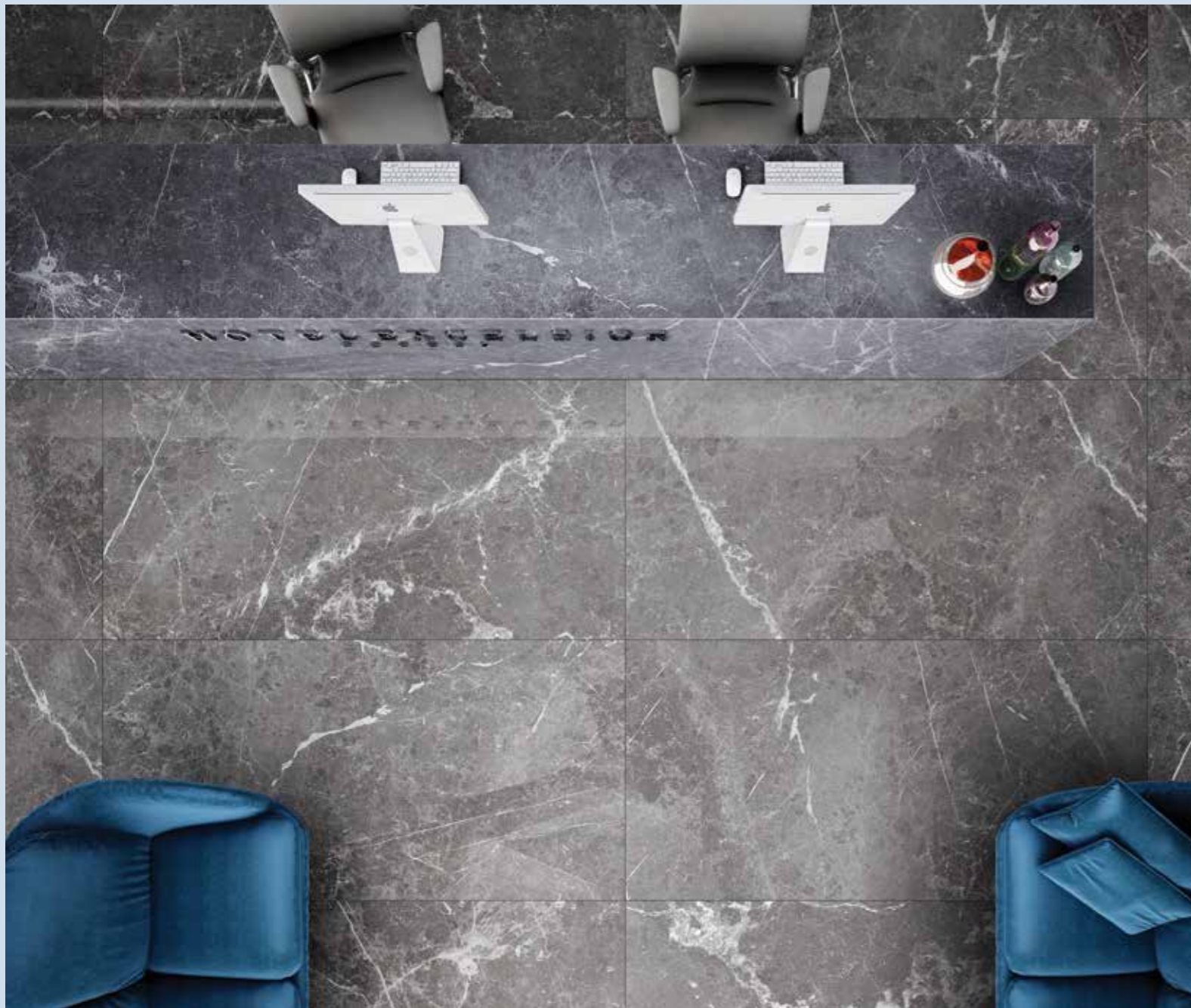

Floor: Blu Del Belgio Clay
Counter: Blu Del Belgio Blue



Kitchen Top and Backsplash: Versilia Marble (Statuario Apuano) open book effect
Furniture: Uni Ivory



Kitchen Top: Elle Marble



Counter: Blu Del Belgio Clay



Wall and Counter: Panda Marble White

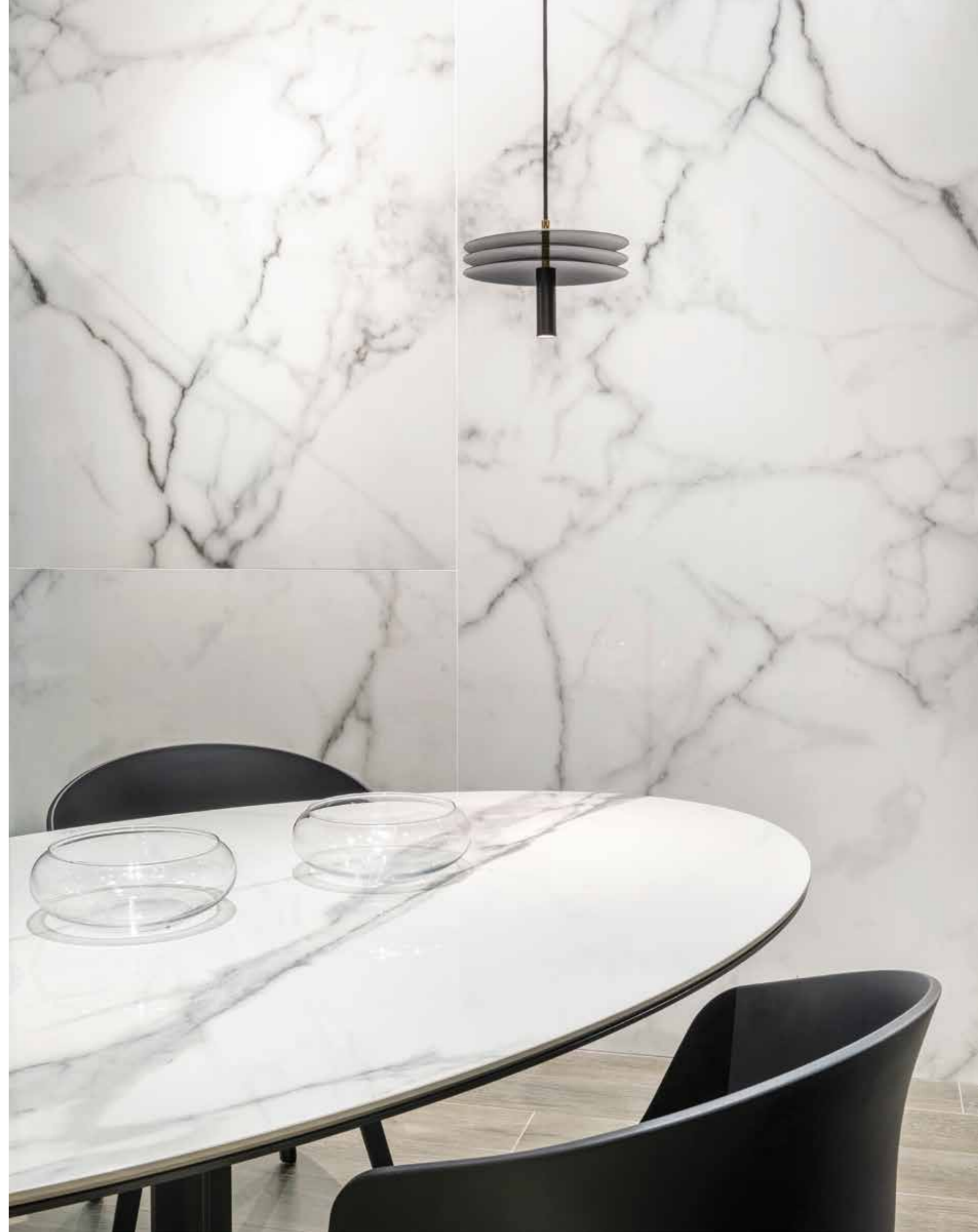

Wall and Table: Versilia Marble Hyper White



Wash Basin: Classic Carrara Grey



Wall and Counter: Classic Carrara Grey



Counter: Blu Del Belgio Blue



Vanity Top, Table and Mirror: Blu Del Belgio Clay

MARBLE



> 14.5 mm
135x305 cm
53.14"x120"

Porcelain Tiles
Full Lappato / Honed

BRECCIA ADIGE



breccia adige grey



BRECCIA DAINO



breccia daino beige



| ITEM | SIZES (cm / inches) | THICKNESS (mm) | CODE (full lappato) | CODE (honed) |
|---------------------|------------------------|-------------------|------------------------|--------------------|
| BRECCIA ADIGE GREY | 135x305 / 53.14"x120" | 14.5 | A83GBRAE-GRY.N0X2P | A83GBRAE-GRY.O0X2P |
| BRECCIA DAINO BEIGE | 135x305 / 53.14"x120" | 14.5 | A83GBRDA-BEE.N0X2P | A83GBRDA-BEE.O0X2P |

MARBLE



> 14.5 mm
135x305 cm
53.14"x120"

Porcelain Tiles
Full Lappato / Honed

BLU DEL BELGIO



blu del belgio blue

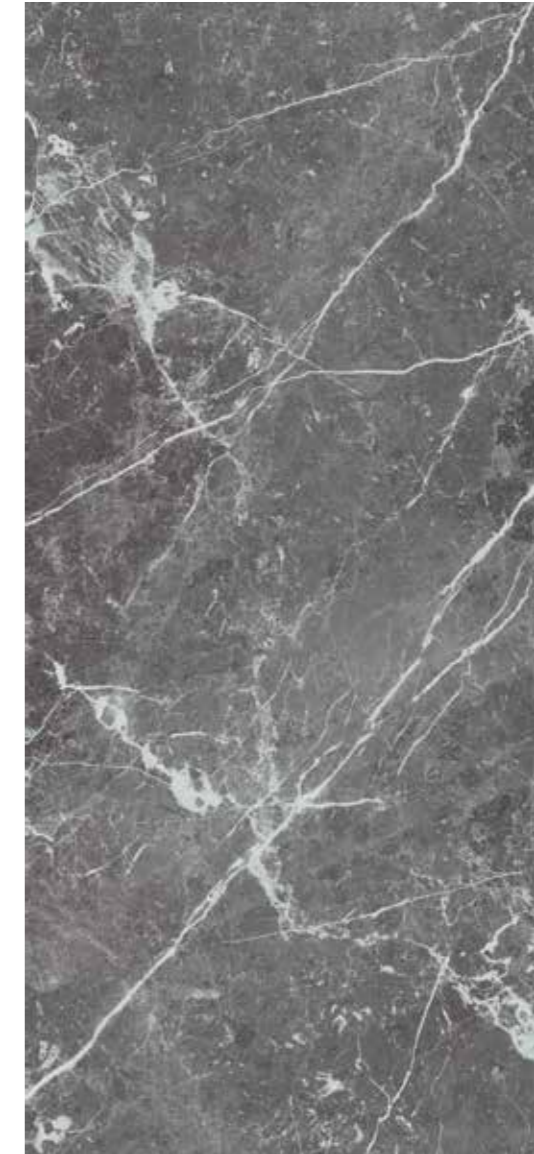

blu del belgio clay

| ITEM | SIZES (cm / inches) | THICKNESS (mm) | CODE (full lappato) | CODE (honed) |
|---------------------|------------------------|-------------------|------------------------|--------------------|
| BLU DEL BELGIO BLUE | 135x305 / 53.14"x120" | 14.5 | A83GZBLB-BL0.G0C2P | A83GZBLB-BLE.O0X2P |
| BLU DEL BELGIO CLAY | 135x305 / 53.14"x120" | 14.5 | A83GZBLB-CL0.G0C2P | A83GZBLB-CLA.O0X2P |

MARBLE

14.5 mm
135x305 cm
 53.14"x120"

Porcelain Tiles
 Full Lappato / Honed

BLU DEL BELGIO BLUE OPEN BOOK EFFECTS

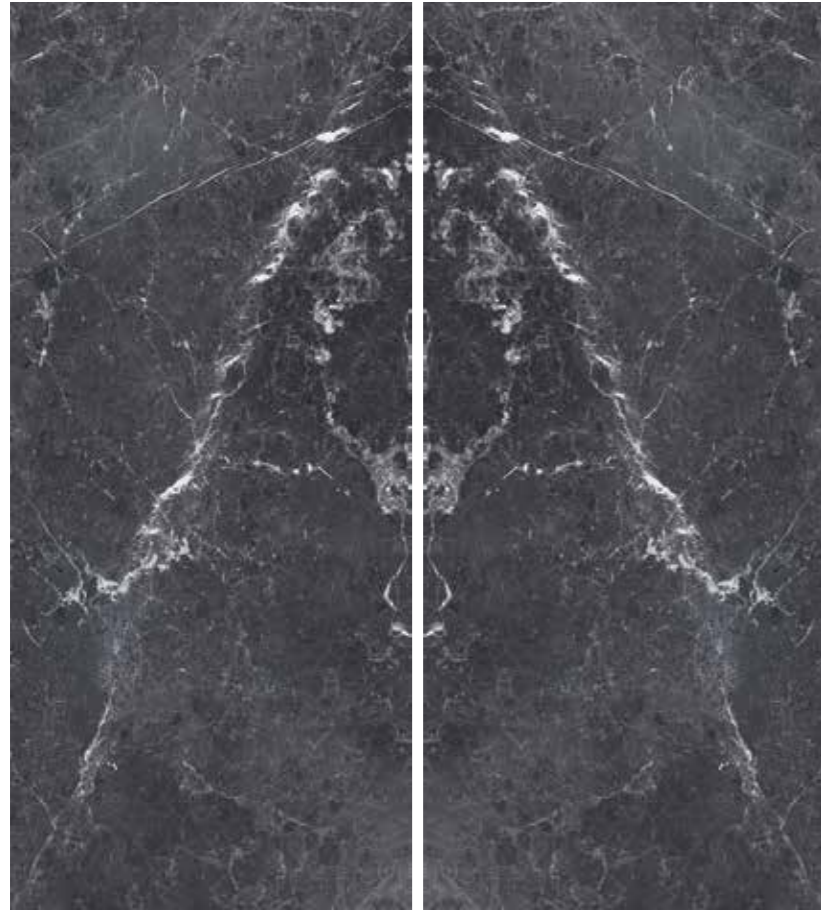

blu del belgio blue
 open book effect (face A)

blu del belgio blue
 open book effect (face B)

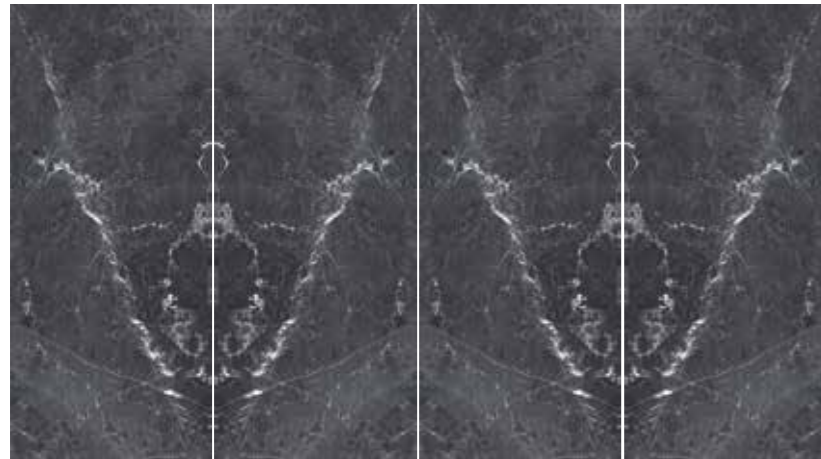
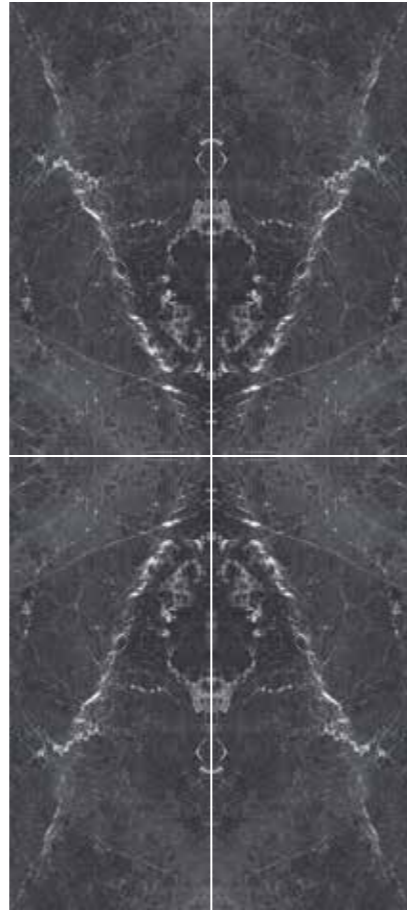

| ITEM | SIZES (cm / inches) | THICKNESS (mm) | CODE (full lappato) | CODE (honed) |
|---|------------------------|-------------------|------------------------|--------------------|
| BLU DEL BELGIO BLUE OPEN BOOK EFFECT (FACE A) | 135x305 / 53.14"x120" | 14.5 | AGD83ZBLBBLEZHA1P | A83GZBLB-BLE.O0A2P |
| BLU DEL BELGIO BLUE OPEN BOOK EFFECT (FACE B) | 135x305 / 53.14"x120" | 14.5 | AGD83ZBLBBLEZHA2P | A83GZBLB-BLE.O0B2P |

14.5 mm
135x305 cm
 53.14"x120"

Porcelain Tiles
 Full Lappato / Honed

BLU DEL BELGIO CLAY OPEN BOOK EFFECTS

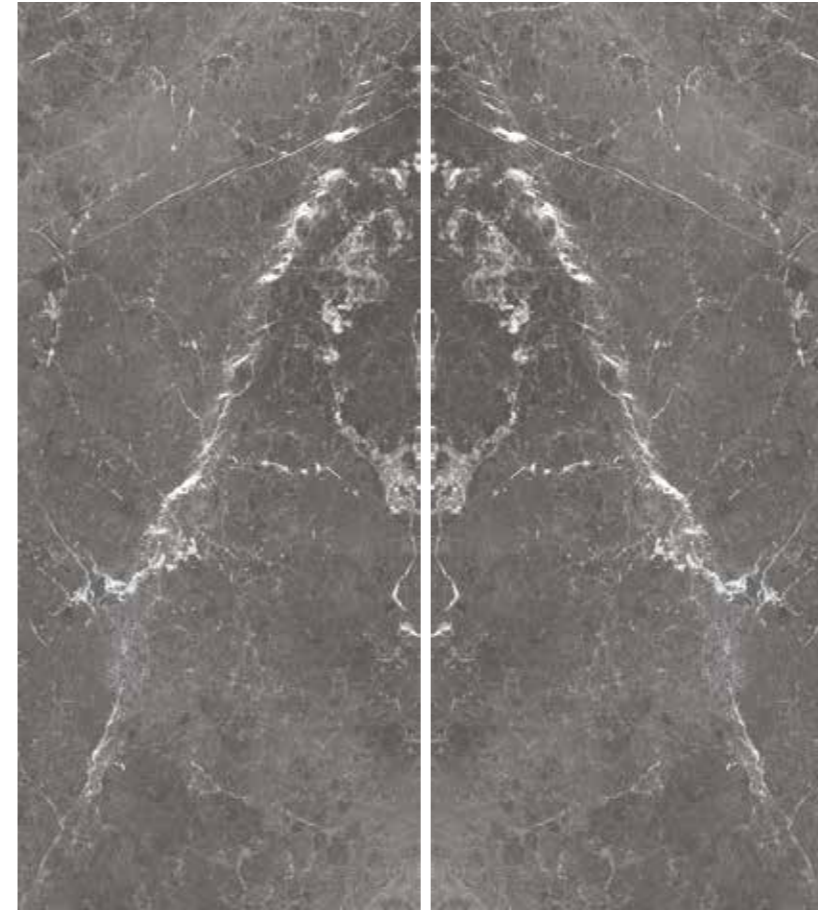

blu del belgio clay
 open book effect (face A)

blu del belgio clay
 open book effect (face B)

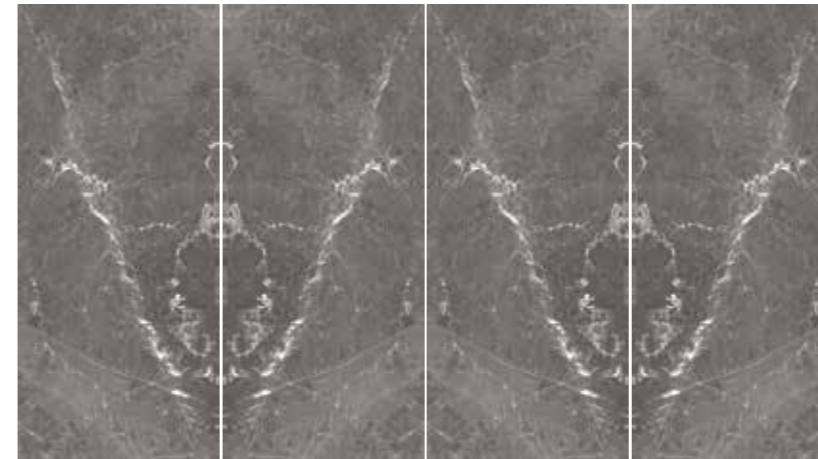
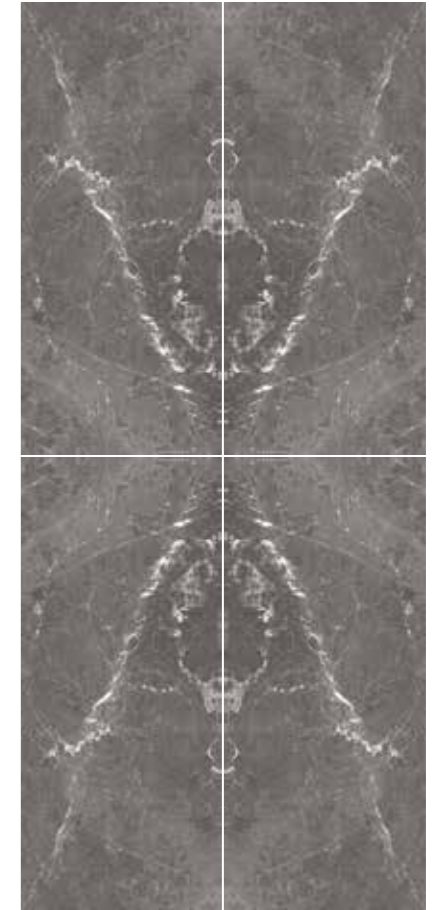

| ITEM | SIZES (cm / inches) | THICKNESS (mm) | CODE (full lappato) | CODE (honed) |
|---|------------------------|-------------------|------------------------|--------------------|
| BLU DEL BELGIO CLAY OPEN BOOK EFFECT (FACE A) | 135x305 / 53.14"x120" | 14.5 | AGD83ZBLBCLAZHA1P | A83GZBLB-CLA.O0A2P |
| BLU DEL BELGIO CLAY OPEN BOOK EFFECT (FACE B) | 135x305 / 53.14"x120" | 14.5 | AGD83ZBLBCLAZHA2P | A83GZBLB-CLA.O0B2P |

MARBLE



14.5 mm
135x305 cm
53.14"x120"

Porcelain Tiles
Full Lappato / Honed / Natural

CALACATTA AFRICA



calacatta africa white

CALACATTA GOLD



calacatta gold white



| ITEM | SIZES (cm / inches) | THICKNESS (mm) | CODE (full lappato) | CODE (honed) | CODE (natural) |
|------------------------|------------------------|-------------------|------------------------|--------------------|--------------------|
| CALACATTA AFRICA WHITE | 135x305 / 53.14"x120" | 14.5 | A83GCCAF-WHE.N0X2P | A83GCCAF-WHE.O0X2P | A83GCCAF-WHE.M0X2R |
| CALACATTA GOLD WHITE | 135x305 / 53.14"x120" | 14.5 | A83GCTAG-WHE.N0X2P | A83GCTAG-WHE.O0X2P | A83GCTAG-WHE.M0X2R |

MARBLE



14.5 mm
135x305 cm
53.14"x120"

Porcelain Tiles
Full Lappato / Honed / Natural

CALACATTA EXTRA



calacatta extra white



ELLE MARBLE



elle marble white



| ITEM | SIZES (cm / inches) | THICKNESS (mm) | CODE (full lappato) | CODE (honed) | CODE (natural) |
|-----------------------|------------------------|-------------------|------------------------|--------------------|--------------------|
| CALACATTA EXTRA WHITE | 135x305 / 53.14"x120" | 14.5 | AGB83CCTEWHEZHSC2P | A83GCCTE-WHE.O0X2P | A83GCCTE-WHE.M0X2R |
| ELLE MARBLE WHITE | 135x305 / 53.14"x120" | 14.5 | AGB83ELLMWHEZHSLP | A83GELLM-WHE.O0X2P | A83GELLM-WHE.M0X2R |

MARBLE

14.5 mm
 135x305 cm
 53.14"x120"

Porcelain Tiles
 Full Lappato / Honed / Natural

CLASSIC CARRARA

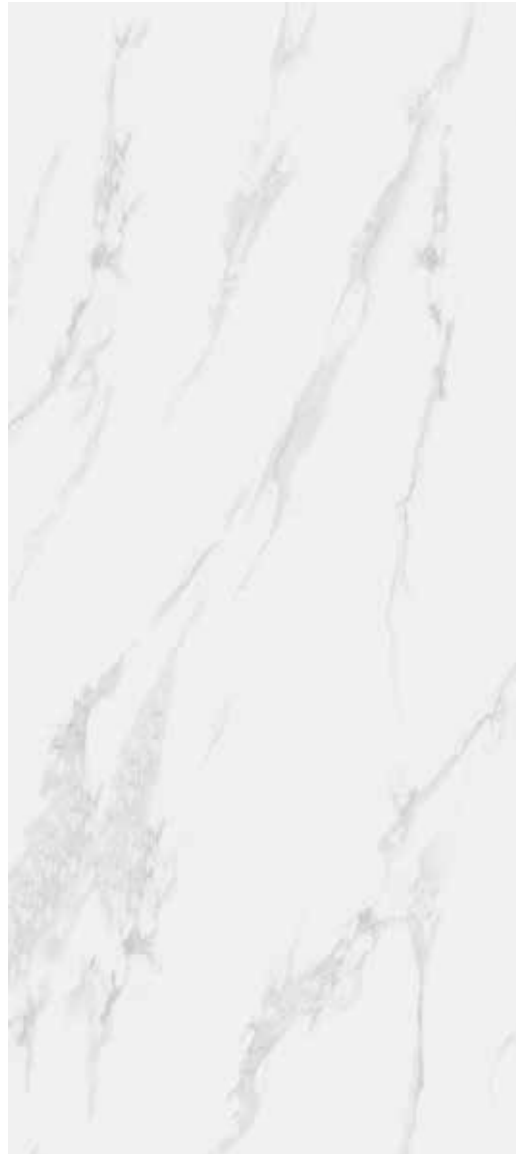

classic carrara hyper white



classic carrara grey



| ITEM | SIZES (cm / inches) | THICKNESS (mm) | CODE (full lappato) | CODE (honed) | CODE (natural) |
|-----------------------------|------------------------|-------------------|------------------------|--------------------|--------------------|
| CLASSIC CARRARA HYPER WHITE | 135x305 / 53.14"x120" | 14.5 | A83GZCRR-HWH.G0C2P | A83GZCRR-HWH.O0X2P | A83GZCRR-HWH.M0X2R |
| CLASSIC CARRARA GREY | 135x305 / 53.14"x120" | 14.5 | A83GZCRR-GY0.G0C2P | A83GZCRR-GRY.O0X2P | A83GZCRR-GRY.M0X2R |

MARBLE

14.5 mm
 135x305 cm
 53.14"x120"

Porcelain Tiles
 Full Lappato / Honed

CLASSIC FIORITO



classic fiorito beige

CLASSIC NEW MARFIL



classic new marfil beige



| ITEM | SIZES (cm / inches) | THICKNESS (mm) | CODE (full lappato) | CODE (honed) |
|--------------------------|------------------------|-------------------|------------------------|--------------------|
| CLASSIC FIORITO BEIGE | 135x305 / 53.14"x120" | 14.5 | A83GZFRT-BE0.G0C2P | A83GZFRT-BEE.O0X2P |
| CLASSIC NEW MARFIL BEIGE | 135x305 / 53.14"x120" | 14.5 | A83GZNMF-BE0.G0C2P | A83GZNMF-BEE.O0X2P |

MARBLE

14.5 mm
135x305 cm
 53.14"x120"

Porcelain Tiles
 Full Lappato / Honed / Natural

CLASSIC CARRARA HYPER WHITE OPEN BOOK EFFECTS



classic carrara hyper white open book effect (face A)

classic carrara hyper white open book effect (face B)

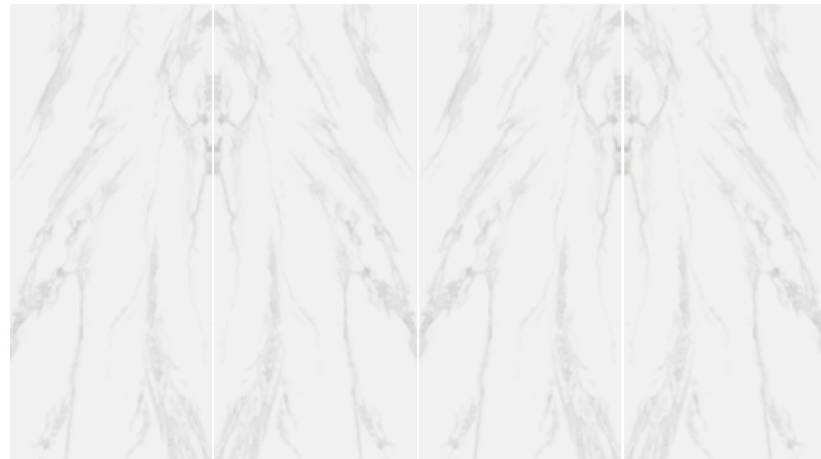

| ITEM | SIZES (cm / inches) | THICKNESS (mm) | CODE (full lappato) | CODE (honed) | CODE (natural) |
|---|-----------------------|----------------|---------------------|--------------------|--------------------|
| CLASSIC CARRARA HYPER WHITE OPEN BOOK EFFECT (FACE A) | 135x305 / 53.14"x120" | 14.5 | AGD83ZCRRHWHZHS1P | A83GZCRR-HWH.O0A2P | A83GZCRR-HWH.M0A2R |
| CLASSIC CARRARA HYPER WHITE OPEN BOOK EFFECT (FACE B) | 135x305 / 53.14"x120" | 14.5 | AGD83ZCRRHWHZHS2P | A83GZCRR-HWH.O0B2P | A83GZCRR-HWH.M0B2R |

14.5 mm
135x305 cm
 53.14"x120"

Porcelain Tiles
 Full Lappato / Honed / Natural



classic carrara hyper white open book effect (face C)

classic carrara hyper white open book effect (face D)



| ITEM | SIZES (cm / inches) | THICKNESS (mm) | CODE (full lappato) | CODE (honed) | CODE (natural) |
|---|-----------------------|----------------|---------------------|--------------------|--------------------|
| CLASSIC CARRARA HYPER WHITE OPEN BOOK EFFECT (FACE C) | 135x305 / 53.14"x120" | 14.5 | AGD83ZCRRHWHZHS3P | A83GZCRR-HWH.O0C2P | A83GZCRR-HWH.M0C2R |
| CLASSIC CARRARA HYPER WHITE OPEN BOOK EFFECT (FACE D) | 135x305 / 53.14"x120" | 14.5 | AGD83ZCRRHWHZHS4P | A83GZCRR-HWH.O0D2P | A83GZCRR-HWH.M0D2R |

MARBLE

 14.5 mm
 135x305 cm
 53.14"x120"

Porcelain Tiles
 Full Lappato / Honed / Natural

CLASSIC CARRARA GREY OPEN BOOK EFFECTS



classic carrara grey
open book effect (face A)

classic carrara grey
open book effect (face B)

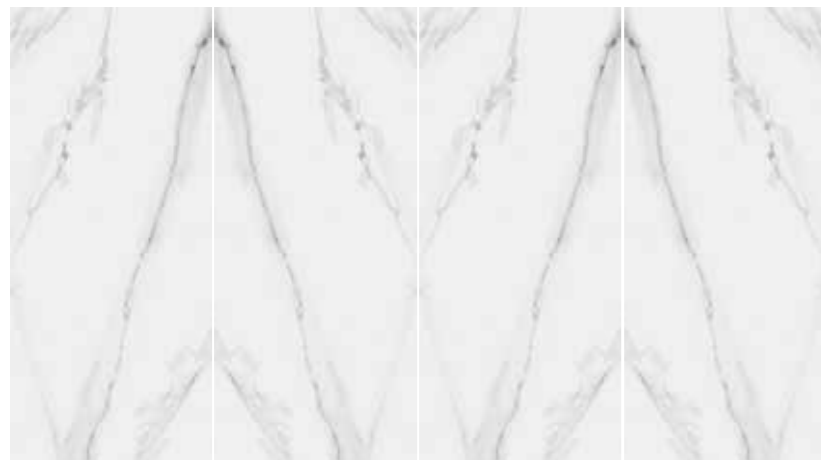
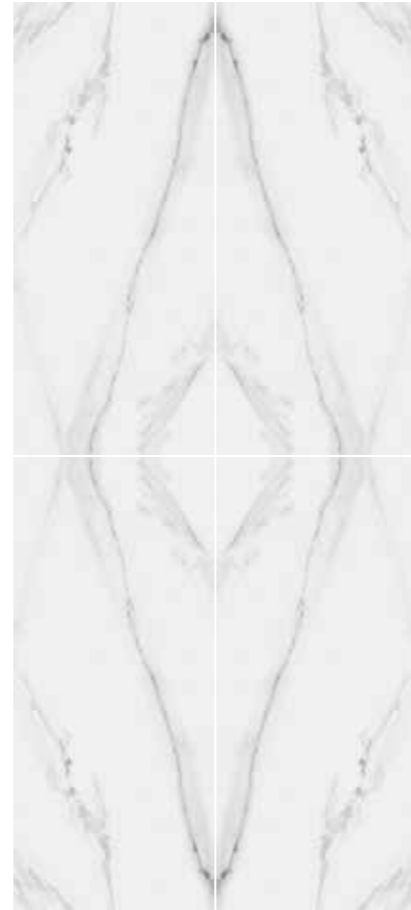

| ITEM | SIZES (cm / inches) | THICKNESS (mm) | CODE (full lappato) | CODE (honed) | CODE (natural) |
|--|------------------------|-------------------|------------------------|--------------------|--------------------|
| CLASSIC CARRARA GREY OPEN BOOK EFFECT (FACE A) | 135x305 / 53.14"x120" | 14.5 | AGD83ZCRRGRYZHSA1P | A83GZCRR-GRY.O0A2P | A83GZCRR-GRY.M0A2R |
| CLASSIC CARRARA GREY OPEN BOOK EFFECT (FACE B) | 135x305 / 53.14"x120" | 14.5 | AGD83ZCRRGRYZHSA2P | A83GZCRR-GRY.O0B2P | A83GZCRR-GRY.M0B2R |

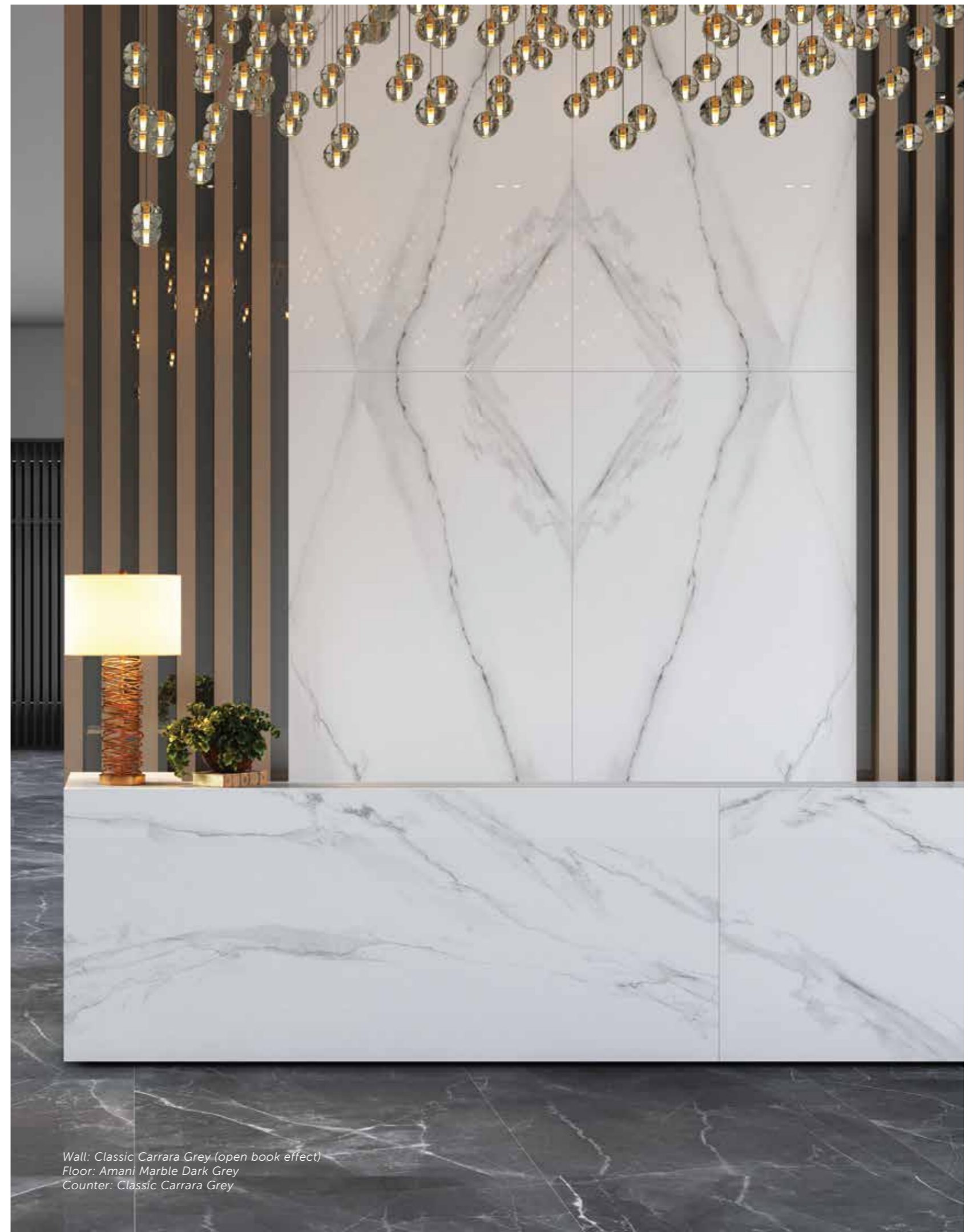

Wall: Classic Carrara Grey (open book effect)
 Floor: Amani Marble Dark Grey
 Counter: Classic Carrara Grey

MARBLE

14.5 mm
135x305 cm
53.14"x120"

Porcelain Tiles
Full Lappato / Honed

CLASSIC ONYX



classic onyx white

CLASSIC FLURRY



classic flurry grey



| ITEM | SIZES (cm / inches) | THICKNESS (mm) | CODE (full lappato) | CODE (honed) |
|---------------------|------------------------|-------------------|------------------------|--------------------|
| CLASSIC ONYX WHITE | 135x305 / 53.14"x120" | 14.5 | A83GZONX-WH0.G0C2P | A83GZONX-WHE.O0X2P |
| CLASSIC FLURRY GREY | 135x305 / 53.14"x120" | 14.5 | A83GZFLU-GY0.G0C2P | A83GZFLU-GRY.O0X2P |

MARBLE

14.5 mm
135x305 cm
53.14"x120"

Porcelain Tiles
Full Lappato / Honed / Natural

MEDICEA MARBLE

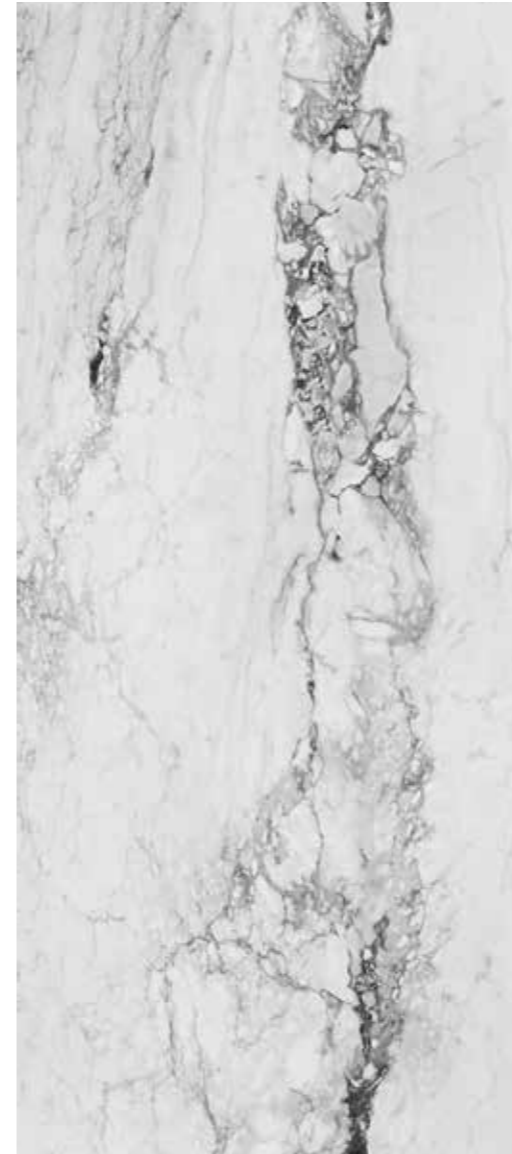

medicea marble white



| ITEM | SIZES (cm / inches) | THICKNESS (mm) | CODE (full lappato) | CODE (honed) | CODE (natural) |
|----------------------|------------------------|-------------------|------------------------|--------------------|--------------------|
| MEDICEA MARBLE WHITE | 135x305 / 53.14"x120" | 14.5 | AGB83MDMBWHZHSC2P | A83GMDMB-HWH.O0X2P | A83GMDMB-HWH.M0X2R |
| PANDA MARBLE WHITE | 135x305 / 53.14"x120" | 14.5 | AGB83PDMBWHEZHSNLP | A83GPDMB-WHE.O0X2P | A83GPDMB-WHE.M0X2R |

PANDA MARBLE



panda marble white



MARBLE

 14.5 mm
 135x305 cm
 53.14"x120"

Porcelain Tiles
 Full Lappato / Honed

PALISSANDRO



palissandro ivory



URBAN MARBLE



urban marble ornate



| ITEM | SIZES (cm / inches) | THICKNESS (mm) | CODE (full lappato) | CODE (honed) |
|---------------------|------------------------|-------------------|------------------------|--------------------|
| PALISSANDRO IVORY | 135x305 / 53.14"x120" | 14.5 | A83GZEBI-IVO.N0X2P | A83GZEBI-IVO.O0X2P |
| URBAN MARBLE ORNATE | 135x305 / 53.14"x120" | 14.5 | A83GURBM-OLE.N0X2P | A83GURBM-OLE.O0X2P |

 14.5 mm
 135x305 cm
 53.14"x120"

Porcelain Tiles
 Full Lappato / Honed / Natural

RAIN MARBLE



rain marble white



| ITEM | SIZES (cm / inches) | THICKNESS (mm) | CODE (full lappato) | CODE (honed) | CODE (natural) |
|-----------------------|------------------------|-------------------|------------------------|--------------------|--------------------|
| RAIN MARBLE WHITE | 135x305 / 53.14"x120" | 14.5 | AGB83RANMWHEZHSC2P | A83GRANM-WHE.O0X2P | A83GRANM-WHE.M0X2R |
| VERSILIA MARBLE WHITE | 135x305 / 53.14"x120" | 14.5 | AGB83VSMBHWZHC2P | A83GVSMB-HWH.O0X2P | A83GVSMB-HWH.M0X2R |

VERSILIA MARBLE



versilia marble white



MARBLE

14.5 mm
135x305 cm
 53.14"x120"

Porcelain Tiles
 Full Lappato / Honed / Natural

VERSILIA MARBLE OPEN BOOK EFFECTS



versilia marble calacatta della piana
 open book effect (face A)

versilia marble calacatta della piana
 open book effect (face B)



| ITEM | SIZES (cm / inches) | THICKNESS (mm) | CODE (full lappato) | CODE (honed) | CODE (natural) |
|---|------------------------|-------------------|------------------------|---------------------|---------------------|
| CALACATTA DELLA PIANA OPEN BOOK EFFECT (FACE A) | 135x305 / 53.14"x120" | 14.5 | AGD83VSMBHWZHSA1P | A83GV SMB-HWH.O0A2P | A83GV SMB-HWH.M0A2R |
| CALACATTA DELLA PIANA OPEN BOOK EFFECT (FACE B) | 135x305 / 53.14"x120" | 14.5 | AGD83VSMBHWZHSA2P | A83GV SMB-HWH.O0B2P | A83GV SMB-HWH.M0B2R |

14.5 mm
135x305 cm
 53.14"x120"

Porcelain Tiles
 Full Lappato / Honed / Natural



versilia marble statuario apuano
 open book effect (face C)

versilia marble statuario apuano
 open book effect (face D)

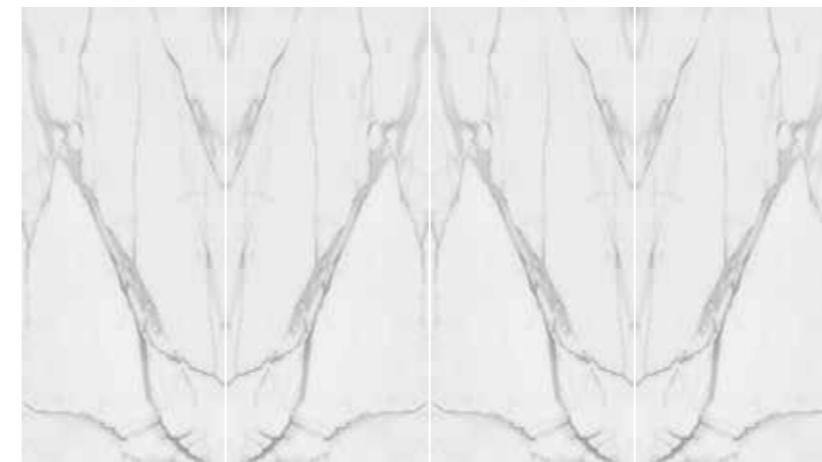

| ITEM | SIZES (cm / inches) | THICKNESS (mm) | CODE (full lappato) | CODE (honed) | CODE (natural) |
|--|------------------------|-------------------|------------------------|---------------------|---------------------|
| STATUARIO APUANO OPEN BOOK EFFECT (FACE C) | 135x305 / 53.14"x120" | 14.5 | AGD83VSMBHWZHSA3P | A83GV SMB-HWH.O0C2P | A83GV SMB-HWH.M0C2R |
| STATUARIO APUANO OPEN BOOK EFFECT (FACE D) | 135x305 / 53.14"x120" | 14.5 | AGD83VSMBHWZHSA4P | A83GV SMB-HWH.O0D2P | A83GV SMB-HWH.M0D2R |

MARBLE

> 14.5 mm
135x305 cm
53.14"x120"

Porcelain Tiles
Full Lappato / Honed

SILK MARBLE



silk marble grey



silk marble beige



silk marble brown



| ITEM | SIZES (cm / inches) | THICKNESS (mm) | CODE (full lappato) | CODE (honed) |
|-------------------|------------------------|-------------------|------------------------|--------------------|
| SILK MARBLE GREY | 135x305 / 53.14"x120" | 14.5 | AGB83SLMBGRYZHSNLP | A83GSLMB-GRY.O0X2P |
| SILK MARBLE BEIGE | 135x305 / 53.14"x120" | 14.5 | AGB83SLMBBEEZHSNLP | A83GSLMB-BEE.O0X2P |
| SILK MARBLE BROWN | 135x305 / 53.14"x120" | 14.5 | AGB83SLMBBRNZHSNLP | A83GSLMB-BRN.O0X2P |



Kitchen Top: Classic New Marfil Beige
Table Top: Silk Marble Brown
Floor: Classic New Marfil Beige

CONCRETE



Wall and Kitchen Top: Behind Beige
Floor: Behind Grey



Wall and Counters: Oslo Concrete 135x305 cm



Wall and Floor: Behind Beige
Kitchen Top: Behind Beige



Table Top: Revive Concrete XL Concrete Grey



Vanity Top: Surface XL Cool grey



Table Top: Revive Concrete XL Concrete Grey

Table Top: Behind Grey

CONCRETE



> 14.5 mm
135x305 cm
53.14"x120"

Porcelain Tiles
Natural

ARAGON CONCRETE



aragon concrete brown

BASIC CONCRETE XL



basic concrete xl dark grey



| ITEM | SIZES (cm / inches) | THICKNESS (mm) | CODE (natural) |
|-----------------------------|------------------------|-------------------|--------------------|
| ARAGON CONCRETE BROWN | 135x305 / 53.14"x120" | 14.5 | AGB83ARCRBRNZMSC2R |
| BASIC CONCRETE XL DARK GREY | 135x305 / 53.14"x120" | 14.5 | AGB83ZBSXDGYZMSNLR |

CONCRETE



> 14.5 mm
135x305 cm
53.14"x120"

Porcelain Tiles
Natural

OSLO CONCRETE



oslo concrete grey



TOKYO CONCRETE



tokyo concrete concrete grey



| ITEM | SIZES (cm / inches) | THICKNESS (mm) | CODE (natural) |
|------------------------------|------------------------|-------------------|--------------------|
| OSLO CONCRETE GREY | 135x305 / 53.14"x120" | 14.5 | AGB83OSCRGRYZMSC2R |
| TOKYO CONCRETE CONCRETE GREY | 135x305 / 53.14"x120" | 14.5 | AGB83TYOCCRGZMSC2R |

CONCRETE

>14.5 mm
135x305 cm
 53.14"x120"

Porcelain Tiles
 Natural

BEHIND



behind light grey



behind grey



behind beige



| ITEM | SIZES (cm / inches) | THICKNESS (mm) | CODE (natural) |
|-------------------|------------------------|-------------------|--------------------|
| BEHIND LIGHT GREY | 135x305 / 53.14"x120" | 14.5 | A83GZBHD-LGY.M0C2R |
| BEHIND GREY | 135x305 / 53.14"x120" | 14.5 | A83GZBHD-GY0.M0C2R |
| BEHIND BEIGE | 135x305 / 53.14"x120" | 14.5 | A83GZBHD-BE0.M0C2R |

CONCRETE

>14.5 mm
135x305 cm
 53.14"x120"

Porcelain Tiles
 Natural

REVIVE CONCRETE XL



revive concrete xl active white



revive concrete xl concrete grey



revive concrete xl summer sand



| ITEM | SIZES (cm / inches) | THICKNESS (mm) | CODE (natural) |
|----------------------------------|------------------------|-------------------|--------------------|
| REVIVE CONCRETE XL ACTIVE WHITE | 135x305 / 53.14"x120" | 14.5 | AGB83REVXACWZMSNLR |
| REVIVE CONCRETE XL CONCRETE GREY | 135x305 / 53.14"x120" | 14.5 | AGB83REVXCRGZMSNLR |
| REVIVE CONCRETE XL SUMMER SAND | 135x305 / 53.14"x120" | 14.5 | AGB83REVXSMSZMSNLR |

CONCRETE



> 14.5 mm
135x305 cm
53.14"x120"

Porcelain Tiles
Natural

SURFACE XL



surface xl off white



surface xl cool grey



surface xl sand



| ITEM | SIZES (cm / inches) | THICKNESS (mm) | CODE (natural) |
|----------------------|------------------------|-------------------|--------------------|
| SURFACE XL OFF WHITE | 135x305 / 53.14"x120" | 14.5 | AGB83ZSFOWHZMSNLR |
| SURFACE XL COOL GREY | 135x305 / 53.14"x120" | 14.5 | AGB83ZSFXCGYZMSNLR |
| SURFACE XL SAND | 135x305 / 53.14"x120" | 14.5 | AGB83ZSFXSANZMSNLR |



Wall and Wash Basin: Surface XL Cool Grey

METAL



Wall and Floor: Icon Metal Light Grey
Kitchen Top: Icon Metal Light Grey



Wall: Icon Metal Redox Brown
Floor: Icon Metal Redox Brown and Behind Grey
Counter: Icon Metal Redox Brown and Uni Black



Kitchen top and Furniture: Icon Metal Light Grey

METAL



> 14.5 mm
135x305 cm
53.14"x120"

Porcelain Tiles
Natural

EVOQUE METAL



evoque metal ice



evoque metal grey



evoque metal brown



| ITEM | SIZES (cm / inches) | THICKNESS (mm) | CODE (natural) |
|--------------------|------------------------|-------------------|--------------------|
| EVOQUE METAL ICE | 135x305 / 53.14"x120" | 14.5 | A83GEVQM-ICE.M0X2R |
| EVOQUE METAL GREY | 135x305 / 53.14"x120" | 14.5 | A83GEVQM-GRY.M0X2R |
| EVOQUE METAL BROWN | 135x305 / 53.14"x120" | 14.5 | A83GEVQM-BRN.M0X2R |

METAL



> 14.5 mm
135x305 cm
53.14"x120"

Porcelain Tiles
Lappato / Natural

ICON METAL



icon metal light grey



icon metal brown



icon metal redox brown

natural

lappato

lappato



| ITEM | SIZES (cm / inches) | THICKNESS (mm) | CODE (natural) |
|------------------------|------------------------|-------------------|--------------------|
| ICON METAL LIGHT GREY | 135x305 / 53.14"x120" | 14.5 | A83GICMT-LIG.M0X2L |
| ICON METAL BROWN | 135x305 / 53.14"x120" | 14.5 | A83GICMT-BRN.M0X2L |
| ICON METAL REDOX BROWN | 135x305 / 53.14"x120" | 14.5 | A83GICMT-RXB.M0X2R |

STONE



Wall: New Travertino Grey
Floor: New Travertino Ivory
Kitchen Top: New Travertino Grey

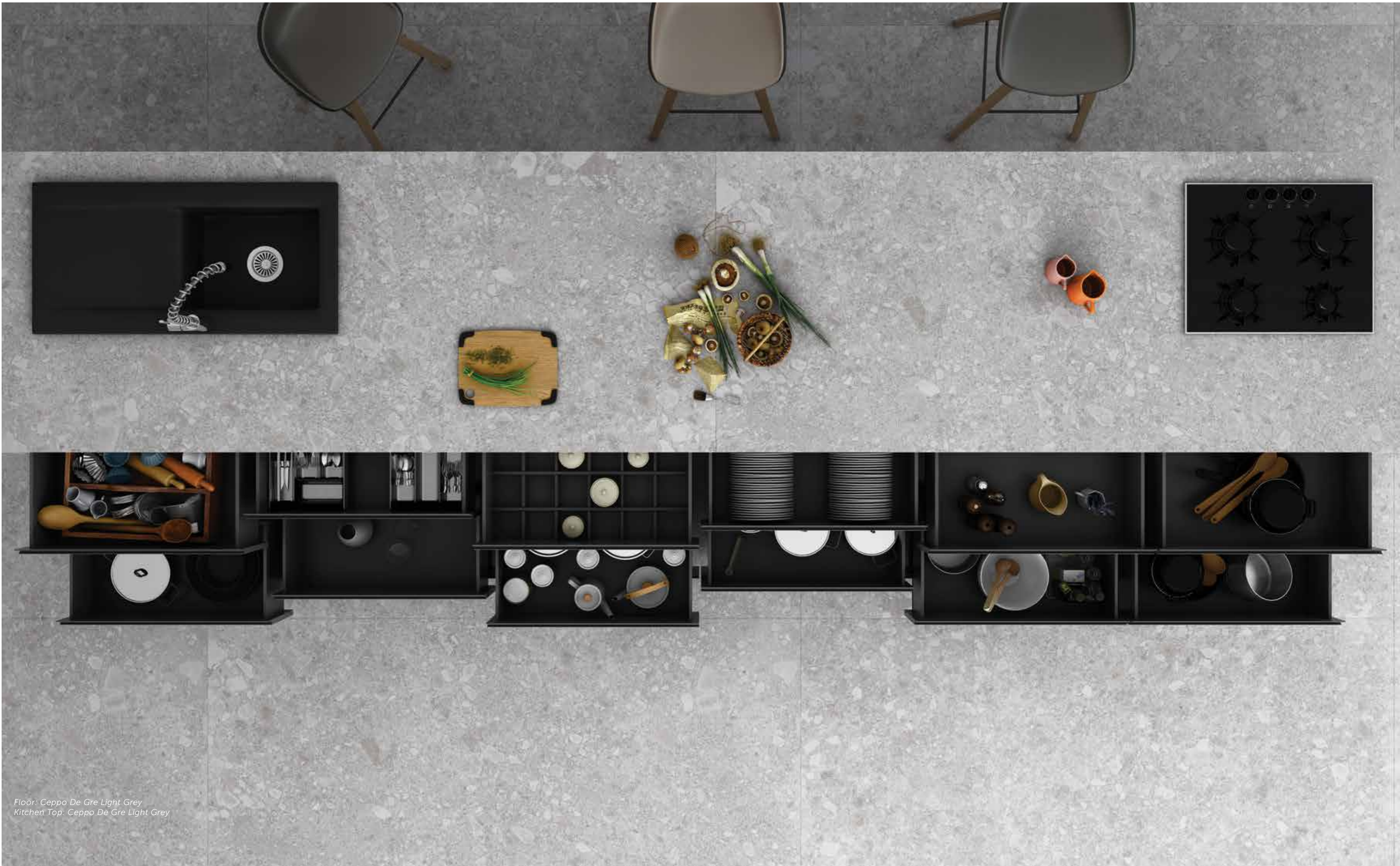

Floor: Ceppo De Gre Light Grey
Kitchen Top: Ceppo De Gre Light Grey



Vanity Top: Iceland Concrete Grey
Kitchen Top: Iceland Concrete Grey
Table Top: Iceland Concrete Grey



Wall: New Travertino Grey
Floor: New Travertino Ivory
Kitchen Top: New Travertino Grey



Wall, Floor and Kitchen top: Basaltina Stone Grey

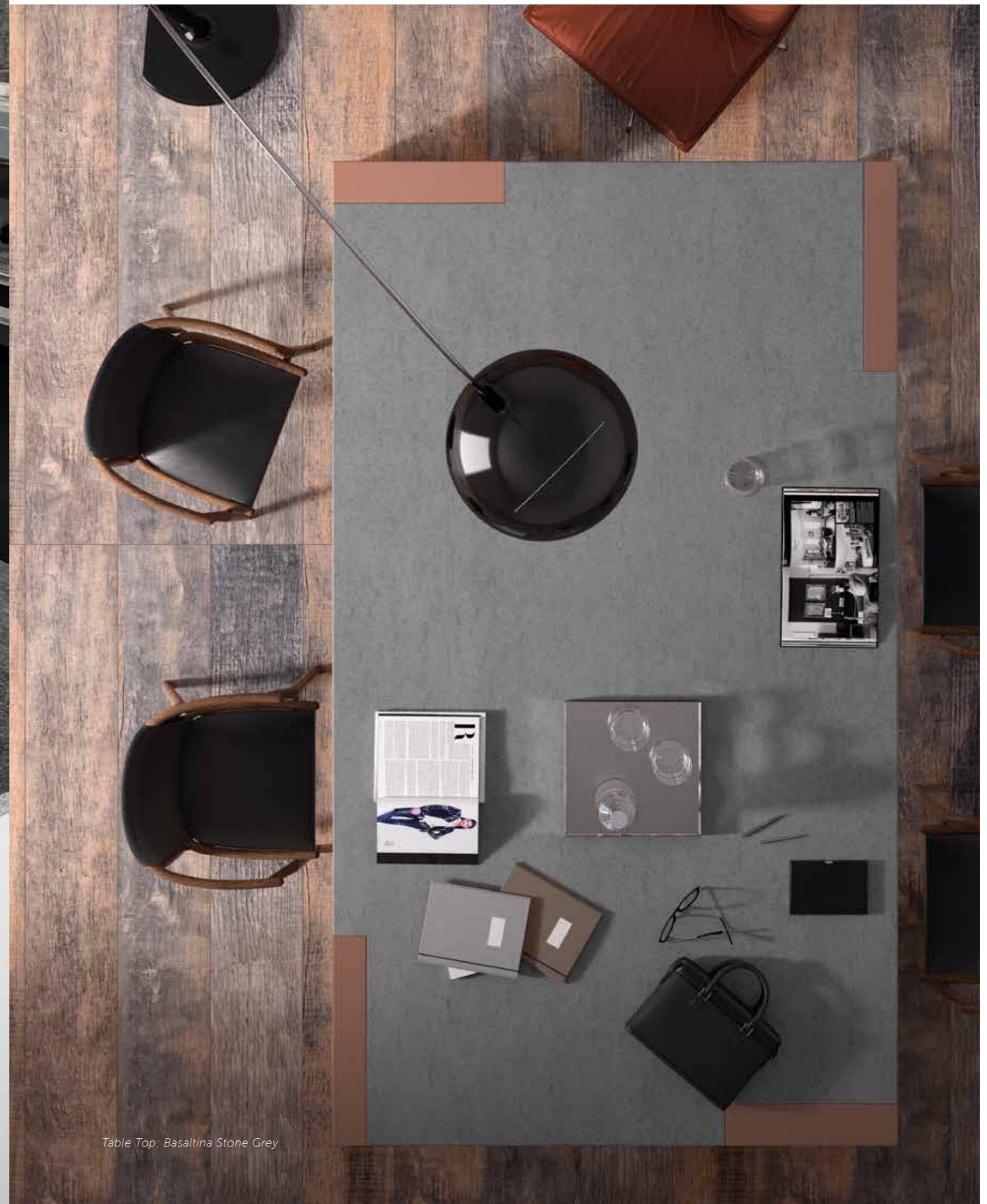

Table Top: Basaltina Stone Grey



Wall and Vanity Top: Macaubas White

Wall: Macaubas White
Kitchen Top: Macaubas White
Floor: Basaltina Grey



Kitchen Top: Basaltina Grey



Wash Basin: Macaubas White

STONE

>14.5 mm
135x305 cm
 53.14"x120"

Porcelain Tiles
 Natural

BASALTINA STONE



basaltina stone grey



ICELAND STONE



iceland stone grey



MACAUBAS



macaubas white



| ITEM | SIZES (cm / inches) | THICKNESS (mm) | CODE |
|----------------------|------------------------|-------------------|--------------------|
| BASALTINA STONE GREY | 135x305 / 53.14"x120" | 14.5 | A83GZBTN-GY0.M0C2R |
| ICELAND STONE GREY | 135x305 / 53.14"x120" | 14.5 | A83GICSE-GRY.M0X2R |
| MACAUBAS WHITE | 135x305 / 53.14"x120" | 14.5 | A83GZMCB-WH0.M0C2R |

STONE



>14.5 mm
135x305 cm
 53.14"x120"

Porcelain Tiles
 Full Lappato / Natural

CEPPO DI GRE'

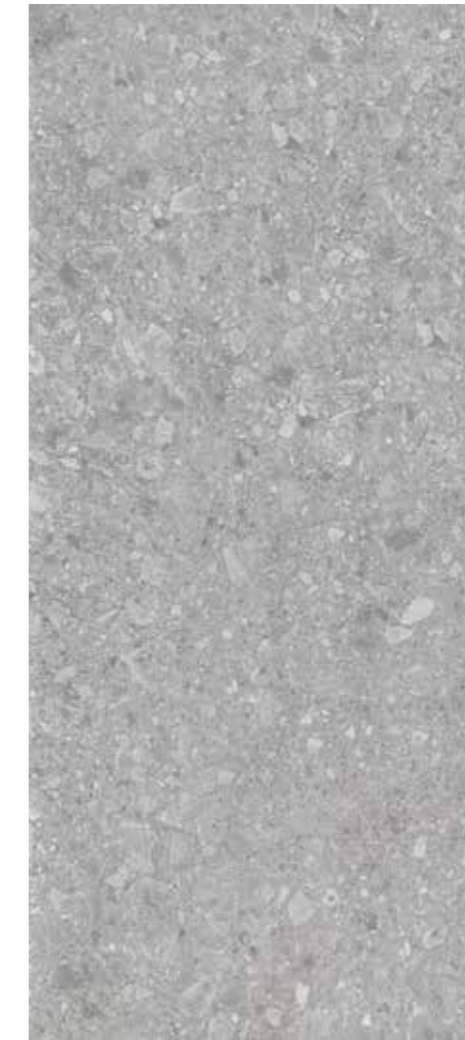

ceppo di gre' light grey



ceppo di gre' mid grey

| ITEM | SIZES (cm / inches) | THICKNESS (mm) | CODE (full lappato) | CODE (honed) |
|--------------------------|------------------------|-------------------|------------------------|--------------------|
| CEPPO DI GRE' LIGHT GREY | 135x305 / 53.14"x120" | 14.5 | A83GCPDG-LIG.N0X2P | A83GCPDG-LIG.M0X2R |
| CEPPO DI GRE' MID GREY | 135x305 / 53.14"x120" | 14.5 | A83GCPDG-MGY.N0X2P | A83GCPDG-MGY.M0X2R |

STONE

14.5 mm
135x305 cm
 53.14"x120"

Porcelain Tiles
 Full Lappato / Natural

NEW TRAVERTINO



new travertino grey



new travertino ivory



new travertino brown



| ITEM | SIZES (cm / inches) | THICKNESS (mm) | CODE |
|----------------------|------------------------|-------------------|--------------------|
| NEW TRAVERTINO GREY | 135x305 / 53.14"x120" | 14.5 | A83GZNTV-GY0.G0C2P |
| NEW TRAVERTINO IVORY | 135x305 / 53.14"x120" | 14.5 | A83GZNTV-IV0.G0C2P |
| NEW TRAVERTINO BROWN | 135x305 / 53.14"x120" | 14.5 | A83GZNTV-BR0.G0C2P |



Wall and Counter: New Travertino Ivory

WOOD



Counter and Furniture: Bengala Bone
Floor: Bengala Bone



Counter: Denver Wood Mud
Floor: Baillie Wood Natural



Counter and Furniture: Bengala Bone
Floor: Bengala Bone

WOOD

> 14.5 mm
135x305 cm
53.14"x120"

Porcelain Tiles
Natural

BENGALA



bengala bone



BAILLIE WOOD



baillie wood natural



DENVER WOOD



denver wood mud



| ITEM | SIZES (cm / inches) | THICKNESS (mm) | CODE |
|----------------------|------------------------|-------------------|--------------------|
| BENGALA BONE | 135x305 / 53.14"x120" | 14.5 | A83GBNGA-BNE.M0X2R |
| BAILLIE WOOD NATURAL | 135x305 / 53.14"x120" | 14.5 | A83GBAWD-NUR.M0X2R |
| DENVER WOOD MUD | 135x305 / 53.14"x120" | 14.5 | A83GDENB-MUD.M0X2R |



Table Top: Denver Wood Mud
Floor: Baillie Wood Natural

UNI



Wall: Uni Ivory
Floor: Uni Dark Grey
Kitchen Top: Uni Hyper White



Wall and Floor: Uni Dark Black
Counter: Uni Dark Black



Wall and Floor: Versilia Marble
Furniture: Uni Dark Black
Kitchen Top: Versilia Marble



Counter: Uni Hyper White

Wall: Classic Flurry
Counter: Uni Ivory



> 14.5 mm
 135x305 cm
 53.14"x120"

Porcelain Tiles
 Natural



UNI

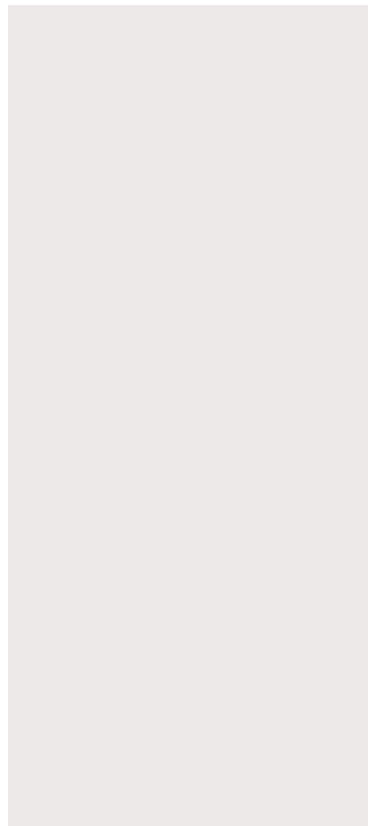

uni hyper white

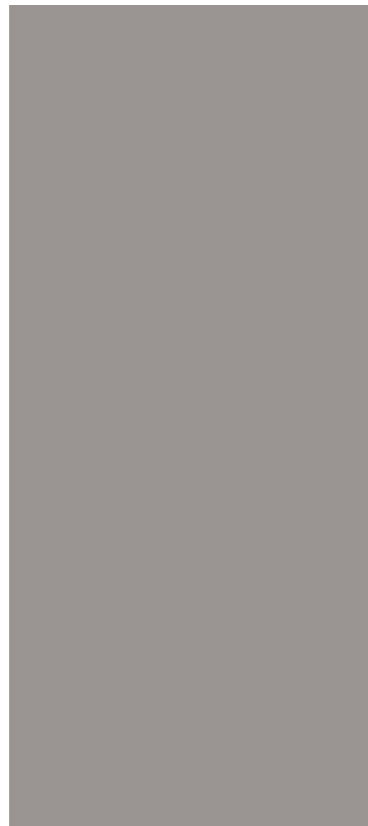

uni light grey



uni dark grey



uni dark black

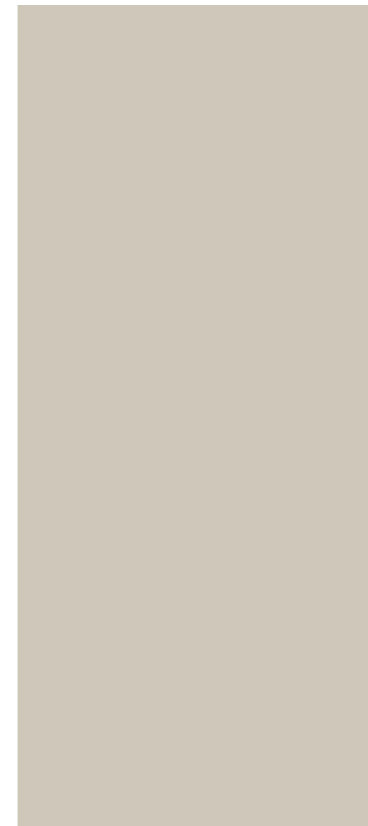

uni ivory



uni light beige



uni beige



uni mocca

| ITEM | SIZES (cm / inches) | THICKNESS (mm) | CODE (polished) | CODE (natural) |
|-----------------|------------------------|-------------------|--------------------|--------------------|
| UNI HYPER WHITE | 135x305 / 53.14"x120" | 14.5 | A83GMAXI-HWH.X0C2P | A83GMAXI-HWH.S0C2R |
| UNI LIGHT GREY | 135x305 / 53.14"x120" | 14.5 | A83GMAXI-LGY.X0C2P | A83GMAXI-LGY.S0C2R |
| UNI DARK GREY | 135x305 / 53.14"x120" | 14.5 | A83GMAXI-DGY.X0C2P | A83GMAXI-DGY.S0C2R |
| UNI DARK BLACK | 135x305 / 53.14"x120" | 14.5 | A83GMAXI-DBK.X0C2P | A83GMAXI-DBK.S0C2R |

| ITEM | SIZES (cm / inches) | THICKNESS (mm) | CODE (polished) | CODE (natural) |
|-----------------|------------------------|-------------------|--------------------|--------------------|
| UNI IVORY | 135x305 / 53.14"x120" | 14.5 | A83GMAXI-IV0.X0C2P | A83GMAXI-IV0.S0C2R |
| UNI LIGHT BEIGE | 135x305 / 53.14"x120" | 14.5 | A83GMAXI-LBE.X0C2P | A83GMAXI-LBE.S0C2R |
| UNI BEIGE | 135x305 / 53.14"x120" | 14.5 | A83GMAXI-BE0.X0C2P | A83GMAXI-BE0.S0C2R |
| UNI MOCCA | 135x305 / 53.14"x120" | 14.5 | A83GMAXI-MOC.X0C2P | A83GMAXI-MOC.S0C2R |

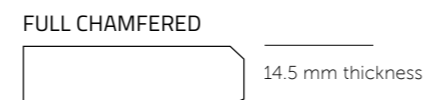
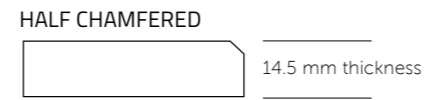
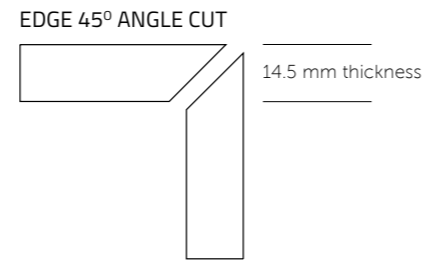

Choosing the right edge for your countertop

In any interior design project it is often the details that set it apart, and choosing your countertop edge is not a detail you want to overlook.

The edge can complete the style of your dream kitchen or bathroom.

Maximus standard and special edges are the finishing touch to your countertop installation.

RAK E-System*

RAK E-System is a worldwide exclusive by RAK Ceramics. It's the ideal and innovative solution to the current needs of designers who need to combine the aesthetics of a natural looking product with the versatility of porcelain slabs.

Thanks to its innovative and high performance materials, Maximus slabs can be easily processed to obtain glossy or matt thick edges, just gluing 2 overlapping slabs (14.5mm+14.5mm) according to the standards of natural stone processing.

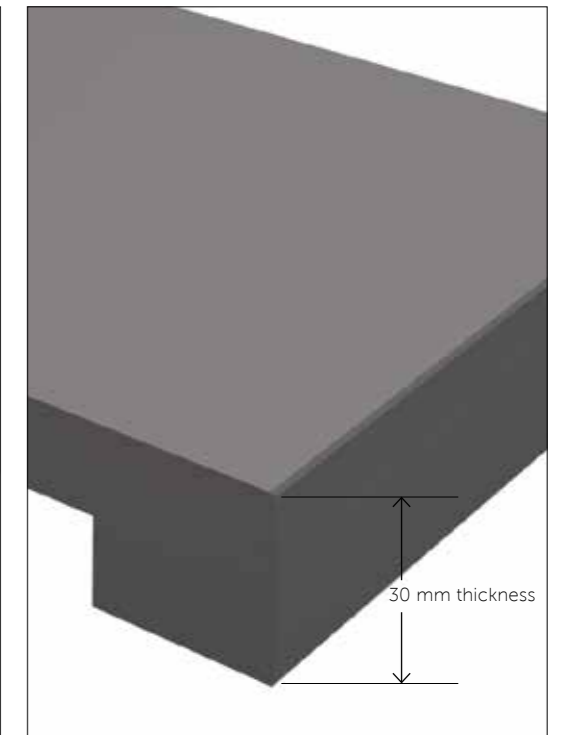
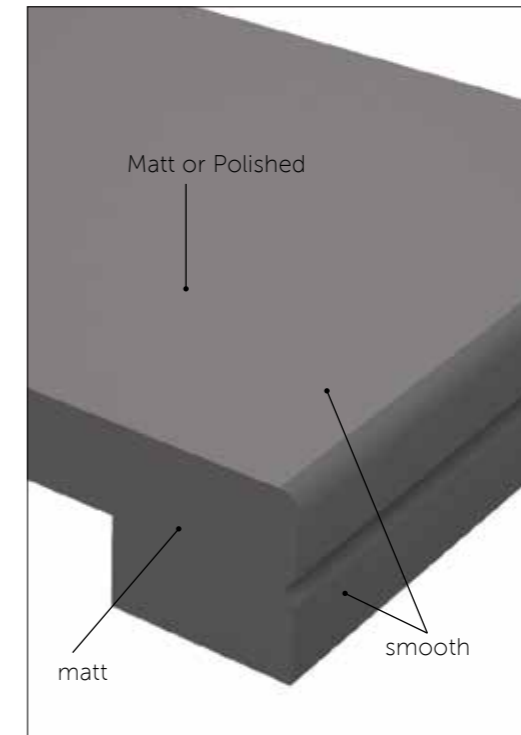
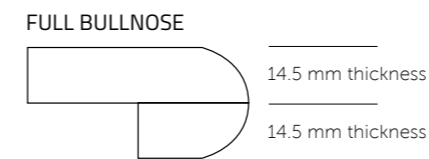
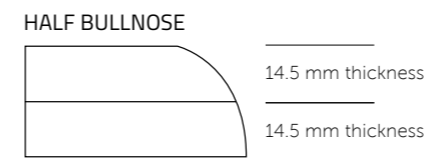
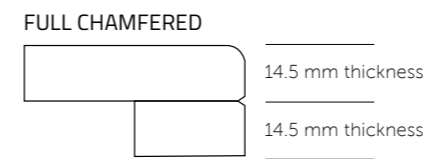
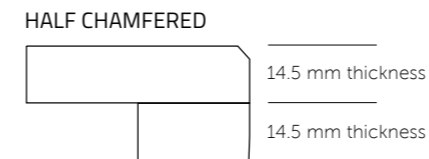

*RAK E-System is only available for UNI



TECHNICAL

SIZES & PACKAGING

TECHNICAL SPECIFICATIONS

EQUIPMENTS AND HANDLING

CLEANING AND MAINTENANCE

Product sizes

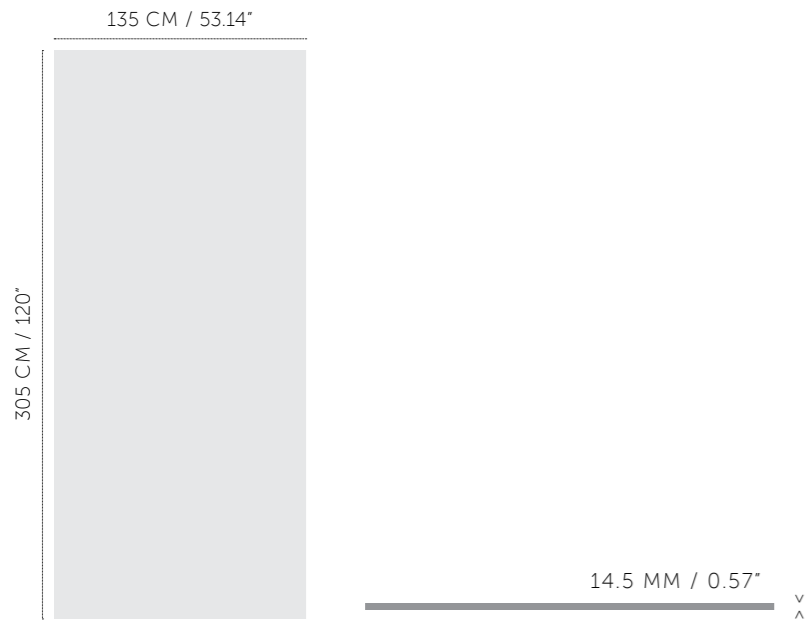

Packaging details

Horizontal Pallet

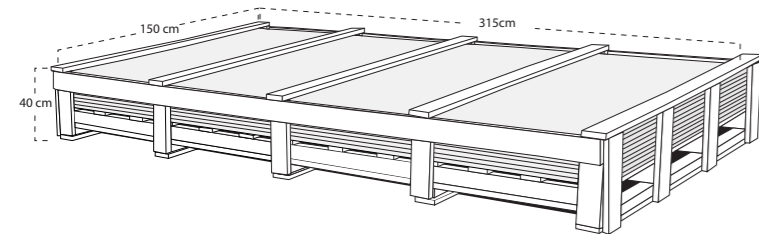

PALLET DIMENSIONS (CM)

| Finish | Length | Height | Width |
|----------|--------|--------|-------|
| Polished | 315 | 40 | 150 |
| Natural | 315 | 40 | 150 |

TILE THICKNESS: 14.5MM

| FINISH | TILE SIZE (CM) | TILE AREA (sqm) | KG per pc | PCS per pallet | TILE AREA per pallet (sqm) | WEIGHT per pallet (kg) |
|----------|----------------|-----------------|-----------|----------------|----------------------------|------------------------|
| Polished | 135x305 | 4.12 | 143 | 10 | 41.2 | 1502 |
| Matt | 135x305 | 4.12 | 150 | 10 | 41.2 | 1572 |

Note: All tile dimensions mentioned above are rectified. Unrectified size is available in +/-140x308cm on request. All weights and thickness mentioned in the above table are approximate average.

A-Frame Vertical Pallet

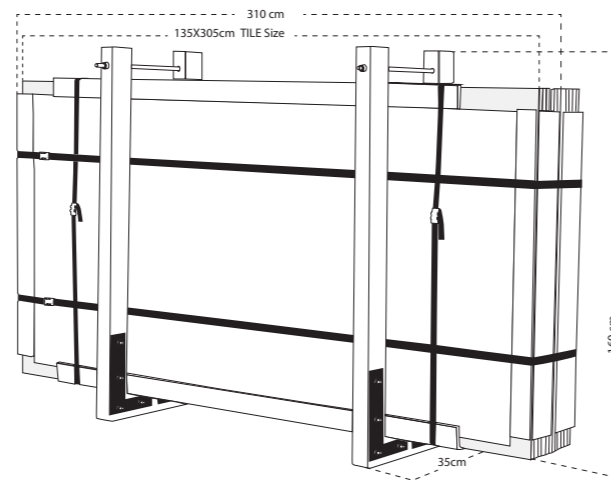

PALLET DIMENSIONS (CM)

| Finish | Length | Height | Width |
|----------|--------|--------|-------|
| Polished | 310 | 160 | 35 |
| Natural | 310 | 160 | 35 |

TILE THICKNESS: 14.5MM

| FINISH | TILE SIZE (CM) | TILE AREA (sqm) | KG per pc | PCS per pallet | TILE AREA per pallet (sqm) | WEIGHT per pallet (kg) |
|----------|----------------|-----------------|-----------|----------------|----------------------------|------------------------|
| Polished | 135x305 | 4.12 | 143 | 10 | 41.20 | 1478 |
| Natural | 135x305 | 4.12 | 150 | 10 | 41.20 | 1548 |

Technical specifications

| TEST DESCRIPTION | STANDARD TEST METHOD | STANDARD REQUIREMENTS | RAK CERAMICS SPECIFICATION | |
|---|----------------------|---|---|---|
| | | | Porcelain Tiles (Natural) | Full Body Porcelain Tiles (Natural/ Polished) |
| Surface Quality | BS EN ISO 10545-2 | A minimum of 95% of the tiles are to be free from visible defects | Minimum of 95% of the tiles are free from visible defects | |
| Length & Width | BS EN ISO 10545-2 | ± 1.0mm | ± 1.0mm | ± 1.0mm |
| Thickness | BS EN ISO 10545-2 | ± 0.5mm | ± 0.5mm | ± 0.5mm |
| Straightness Of Sides | BS EN ISO 10545-2 | ± 0.8mm | ± 0.8mm | ± 0.8mm |
| Rectangularity | BS EN ISO 10545-2 | ± 1.5mm | ± 1.2mm | ± 1.2mm |
| Surface Flatness: Centre Curvature | BS EN ISO 10545-2 | ± 1.8mm | ± 1.8mm | ± 1.8mm |
| Surface Flatness: Edge Curvature | BS EN ISO 10545-2 | ± 1.8mm | ± 1.5mm | ± 1.5mm |
| Surface Flatness: Warpage | BS EN ISO 10545-2 | ± 1.8mm | ± 1.5mm | ± 1.5mm |
| Water Absorption | BS EN ISO 10545-3 | ≤ 0.5% | ≤ 0.4% | ≤ 0.1% |
| Breaking Strength* | BS EN ISO 10545-4 | ≥ 1300 N ≥ 700 N | ≥ 3500 N - | ≥ 3500 N - |
| Modulus Of Rupture* | BS EN ISO 10545-4 | ≥ 35 N/mm ² | ≥ 40 N/mm ² | ≥ 40 N/mm ² |
| Resistance To Deep Abrasion | BS EN ISO 10545-6 | ≤ 175 mm ³ | - | ≤ 150 mm ³ |
| Resistance To Surface Abrasion | BS EN ISO 10545-7 | Report abrasion class | PEI CLASS 2-5 | - |
| Coefficient Of Linear Thermal Expansion | BS EN ISO 10545-8 | Test method available | ≤ 7 X 10 ⁻⁶ /°C | ≤ 7 X 10 ⁻⁶ /°C |
| Resistance To Thermal Shock | BS EN ISO 10545-9 | Test method available | No visible defect | No visible defect |
| Frost Resistance | BS EN ISO 10545-12 | Required | No crazing | No visible damage |
| Resistance To Household Chemicals & Swimming Pool Salts | BS EN ISO 10545-13 | Minimum B | No visible damage | Class A No visible effect |
| Resistance To Low Concentrations Acids & Alkalis | BE EN ISO 10545-13 | Manufacturer to state classification | Class A No visible effect | Class LA No visible effect |
| Resistance To High Concentrations Acids & Alkalis | BS EN ISO 10545-13 | Test method available | Class LA No visible effect | Class HA No visible effect |
| Resistance To Staining (Natural) | BS EN ISO 10545-14 | Min. Class 3 | Min. Class 4 Stains removed | Min. Class 3 Stains removed |
| Resistance To Staining (Polished) | BS EN ISO 10545-14 | Test method available | - | Min. Class 2 Stains removed |

Note: This technical specifications are applicable only to tiles in choice "A".

* Test performed using 100X100 cm cut pieces from the slab.
* Thickness is nominal

Suggested equipment

| HANDLING EQUIPMENT | CUTTING AND DRILLING EQUIPMENT | INSTALLATION AND LEVELLING EQUIPMENT | CLEANING AND MAINTENANCE |
|---|---|---|---------------------------|
| Aluminum Parallel profile with crossbars and Suction Vacuum suction cups with vacuum gauge | Compass device with suction cups for Circular Cuts | Compact Vibrator or Tile Beater | Brooms |
| Tile Cart Trolley | Free cut guide with complete outfit Max. Cut of length – 156 cm | RLS 3D Clips for tiles | Floats with abrasive pads |
| Double Suction Cups | Free Cut Extension | Wedges (for Anti-Chipping / Anti-Scratching preventing platforms) | |
| Modular Work Bench BM180 | Cutting off pliers for tile/slabs | Adjustable pliers for wall and floor covering | |
| Modular Work Bench BM180 BM180 Plus (Perfect Workstation for large format tiles up to 160cm width) | Diamond polishing pad | Low-speed mixer | |
| | Diamond for edge and side polishing | Rubber Grout floats | |
| | Diamond Blades for simultaneous cutting and grooving | Slant ridge notched trowel | |
| | | Diamond for edge and side polishing | |

Handling Maximus

- Maximus extra-large format slabs arrive in oversized crates, which require specific Handling equipment to prevent from damage occurring during forklift operation, specific fork sizes must be used. For example, to handle a crate of 135cm x 305cm tiles from the side, 112cm/ 44" long forks are recommended.
- To handle the same crate from the narrow end requires forks that are at least 213cm/ 84" long. Lifting multiple crates with longer forks may require forklifts with a greater lift capacity.
- Specialized tools and equipment are currently available for the handling, installation and cutting of large porcelain surfaces. Innovative trowels with unique notch configurations can help increase the consistency of the mortar coverage on the back of the tile.
- To increase rigidity and limit twisting, use a system composed of parallel and transverse guides.
- For a perfect adhesion clean the slab and the suckers with a damp sponge.
- The suckers run along the guides and adhere to the slab. Make sure that a vacuum is created between the device and the surface.
- A single guide device can be used for sizes of maximum length.
- Use four operators at a time to carry out handling operations of large size slabs.
- Lift the slab along the long side and hang it vertically to the handles of the frame.
- For the large size slab a suitably reinforced trolley is recommended. Set the guides to the trolley for carrying the slab.
- Follow the same procedure for handling the 120x240cm and all other sub-sizes, where only two operators are sufficient.

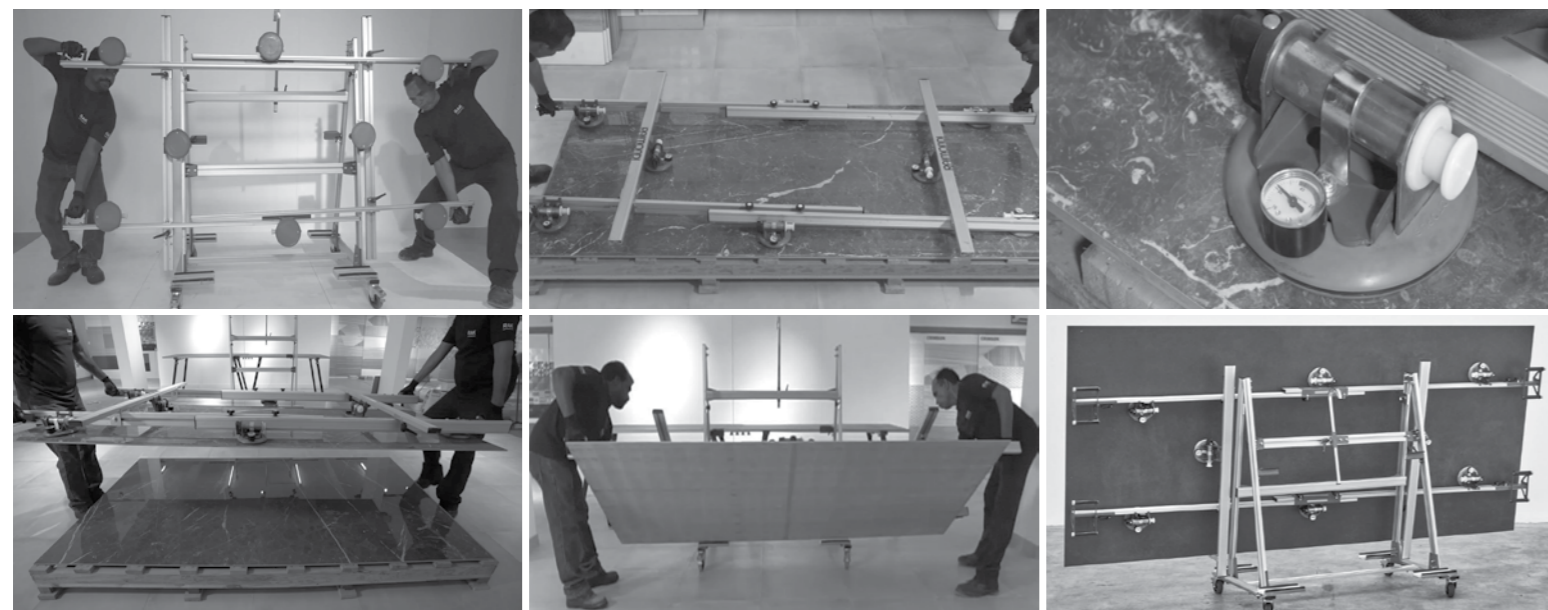
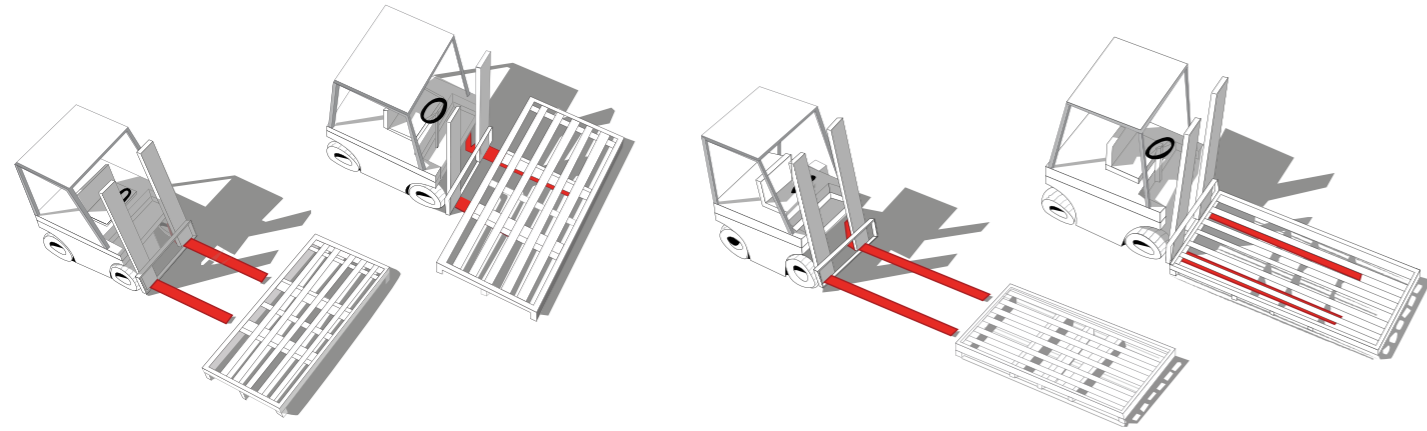

Cut-to-pieces and drilling

- RAK Ceramics recommends the use of special designed devices for handling as well as cutting and laying of big slabs.
- Handle slab with a proper and professional trolley of aluminum parallel profile with crossbars and vacuum suction cups along with a vacuum gauge. Please use double suction cups for slabs above 300cm. This could make sure that appropriate vacuum is created between the device and the slab. Lift the slab and keep it vertically to the trolley frame.
- Keep the slab on a stable, flat and intractable surface. For successful cutting and drilling, RAK Ceramic recommend using a professional modular workbench with aluminum profiles and proper cutting tools for each type of cut.
- Set the cutting unit on the tile so that the references coincide with the marked lines and lock it with the appropriate suckers. Score the slab from one edge to the other, being carefully maintaining the same pressure while moving.
- When the cut has been made, move the slab until the slit line sticks out a 10 to 15 cm from the workbench. Start hew from both sides using appropriate cutting-off pliers and follow the scoring line to complete the hew.
- Smooth rough edges and sides with an appropriate diamond polishing pad.
- To drill internal cutouts from the slab, first you need to draw the guide lines. For circular cuts, use the compass device with suction cups. For rectangular cut, drill first a 5 – 7 mm hole at the corners of the rectangle shape, using a non-percussion drill. For a better drilling always, keep the surface and drill a little bit wet. Then Follow the drilled lines using a diamond-blade angle grinder and then finish off the edges with a diamond-polishing pad. Round holes (4) must be made in wet drilling, using diamond-blades. Start engraving the surface with a 75 degrees point angle, then straighten out the drill avoiding excessive pressure on the slab. Also, in this case finish with a diamond-polishing pad.
- Manual traction devices are available, in order to make a finishing cut at 45° and thus enable special applications of the material.



RAK CERAMICS
P.O. Box 4714, Ras Al Khaimah,
United Arab Emirates (U.A.E.)
Tel.: +971 7 2467000
Fax: +971 7 2445270
Email : info@rakceramics.com

RAKCERAMICS.COM

RAKCERAMICS.COM

RAK
CERAMICS